



DEVELOPMENT OF A SINGLE STAGE ROSELLE CALYX EXTRACTOR

N. Aneke^{1,*}, W. Okonkwo¹, C. Mbajiorgu¹, O. Ani¹, O. Udebuani¹

¹Department of Agricultural and Bioresources Engineering, University of Nigeria, Nsukka

*corresponding author (Email: nneoma.aneke@unn.edu.ng)

Article history: Received 24 July, 2022. Revised 22 October, 2022. Accepted 24 October, 2022

Abstract

An 8-litre capacity roselle calyx extractor was developed with Arduino based temperature controls ranging from 30 to 100°C. Performance evaluation conducted on the extractor showed that efficiency of the extractor increased as the weight of the calyces decreased at constant mass of water which ranged from 55% to 89%. The effect of extraction time (5, 10 and 15 minutes), process temperature (30, 50, 75 and 100°C) and calyx-water mass ratio (1:50, 1:20 and 1:10) on the pH, density and colour of the extract was determined. The pH ranged from 2.4 to 2.9 and density was from 1.02 to 1.05gcm⁻³. Statistical analysis conducted showed that temperature and calyx-water mass ratio has a linear significant effect ($p < 0.001$) on all the responses while time had a linear significant effect ($p < 0.001$) on all responses except density. Time and temperature had interaction significant effect ($p < 0.01$) on pH, while temperature and calyx-water ratio had interaction significant effect ($p < 0.01$) on the density of the extract. Calyx-water ratio had a quadratic significant effect ($p < 0.001$) on the pH and colour of the extract. The contour plots presented the interactions between the factors and their responses. This study demonstrated that roselle calyces extract can be produced more efficiently than practices currently available and also that processing conditions are very important in the quality of extracts produced.

Keywords: Roselle, Extractor, Efficiency, Temperature, Density, Colour.

1.0 INTRODUCTION

Roselle (*Hibiscus sabdariffa*) known as *zobo* in Nigeria is an annual crop found in sub-Saharan Africa, Asia and Central and South America [1]. *Hibiscus sabdariffa* is commonly propagated for its red calyx. The seeds are also comprises of oils that can be used for cooking, soap making and biodiesel production [2,3]. It is usually grown with the aim of using the calyx of their flowers to create a soft drink highly cherished all over the world precisely for the perception of brilliance carried and its red color due to its high nutritional and medicinal content [4,5]. The calyces contains vitamins, antioxidants and bioactive compounds which makes it have great health benefits which include reduction of risks of heart diseases, cancer, hypertension and stroke [6–9]. Recent studies also shows its anti-diabetic properties of the extracts gotten from the calyces [10,11]. The extracts are used as food additives for pastries, ice-cream,[12–14].

Roselle drinks are made by extracting the solute content of the calyces using water usually at an

elevated temperature about 90°C to 100°C and then flavoring and sweetening of the extract [15]. Roselle drinks are highly enjoyed all over the world especially when it is laced with sweet fruits juices such as pineapples, oranges and apples and spices such as ginger, garlic and cloves,[16] and then sweetened with sugar or honey and sometimes non-nutritive sweeteners such as aspartame, sucralose and saccharine. Roselle drinks have the potential to compete favorably with non-alcoholic fruit wines [17,18] if well prepared because it has a lot of qualities in its favour which are brilliant colour, great taste and high nutritional and medicinal value.

One of the major challenges of the processing of the drinks is non-availability of extracting equipment which makes producers depend on the traditional way of producing the extract. The traditional production of roselle drinks entails the use of pots to boil the calyces in water and then separating using decantation or sieving method. This can be very dangerous to the producer as there is a risk of hot liquid scalding. A lot

of people prefer to produce at home as against buying commercial ones because they are sure of the quality and no additional additives have been added unto them. Attempts have been made by researchers on roselle calyces extraction but the limitation is that the design is cumbersome and cannot be used in a domestic environment [19].

The knowledge of the physical properties of roselle extract and how it can be affected by processing conditions can never be over emphasized. These physical properties have a relationship with the contents of the juice. The pH of the extracts indicate an existence of organic acids while the red colour indicates a strong presence of antioxidants specifically anthocyanin. The density is directly related to the quantity of solute that was diffused into the solvent [1,5,20]. The lower the pH the more the organic acids present in the extract. Anthocyanin is a very important antioxidant that is responsible for the medicinal quality of roselle calyces extracts [20].

The objective of this study is to design, construct and conduct a performance evaluation on a single stage roselle calyx extractor with temperature controls. Also, to determine the effect of time, temperature and calyx-water mass ratio on the physical properties (pH, density and colour) of the extract.

2.0 MATERIALS AND METHODS

The mechanical and electronic materials used were sourced locally from Ogbete main market, Enugu Nigeria. The drawing was made using AutoCAD 2017. The 2D drawing is as shown in figure 1. The extractor is made up of the processing and the control section. The processing section is where the calyces and solvent are put together to produce the extract while the control section is made up of electronic components that are used to control the temperature of the system. Figure 2 shows a picture of the extractor.

2.1 DESIGN CONSIDERATIONS

The selection of materials was such that the parts that come in contact with the food material are made of stainless steel and the part not in contact is made of galvanized steel. The stainless steel though expensive compared to galvanized or mild steel is necessary because of the nature of the roselle extracts which is liquid and slightly acidic which can cause rusting in a metal of lesser quality.

2.2 DESCRIPTION OF THE PARTS

The developed single stage roselle calyx extractor is as shown in Figure 2. The extractor has the following components.

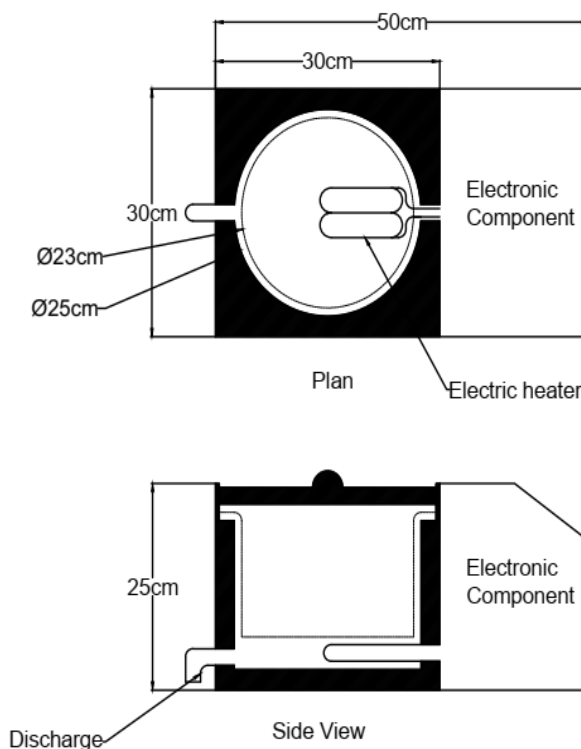

Figure 1: 2D orthographic drawing of the single stage extractor

The vessel: Is made of stainless steel. The choice of material is as a result of the presence of water and organic acids during extraction which the vessel will have direct contact with. Its dimension is 25cm diameter and 22cm depth, the maximum volume is 8 litres.

The sieve: Serves as a false bottom for the extractor and is made of stainless steel as well, because of its direct contact with water and organic acids as well. It is 10mm mesh size and has dimensions of 23cm diameter and 15cm depth. It makes it easy to separate the spent calyces from the extract.

Heating element: Is used to heat up the water to the required temperature it is located at the base of the vessel. It has a 2kW power rating. It is controlled electrically by the temperature control unit.

Fiberglass: Is used to insulate the heated vessel from the environment and from the electronic section. To avoid the heat damaging the electronic components of the appliance.

The casing: Is made of galvanized steel was used to encase the whole system from the vessel to the insulator and then the electronic component of the

appliance. It is a cheaper alternative to stainless steel but not as durable in the presence of moisture.

Discharge tap: Is made of plastic with ½ inch diameter. The extract is discharged through the tap by gravity after extraction.

Thermocouple: Is a sensor used to detect the temperature of the extracting system and communicating to the controller.

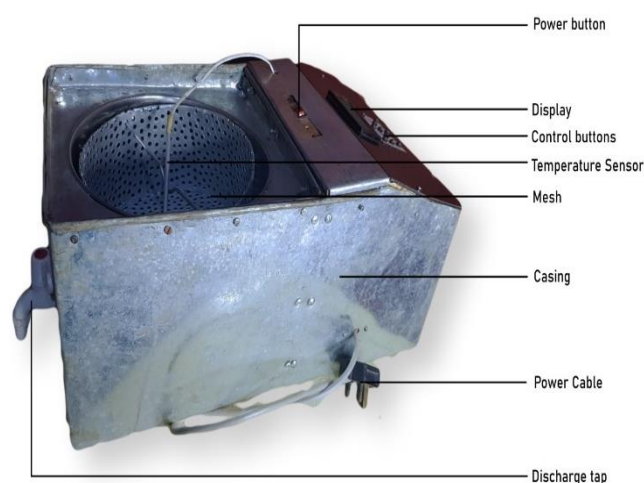

Figure 2: Developed roselle extractor

2.3 THE TEMPERATURE CONTROL UNIT

The components of the control unit include Arduino Uno board, transformer (12 volt, 2 amps), digital temperature and humidity sensor (DHT11), temperature sensor (LM35), integrated circuit diode (2amp), a relay (12V), LCD inter-integrated circuit (i²c) adapter, capacitors (1000uf 16V, 0.1uf), voltage regulator (LM 7808), 1k resistor, diode (1N4007), header pins (M&F), transistor (BC547), red and green LEDs, soldering lead, switch, push button, Veroboard, liquid crystal display (LCD), connecting wires.

Figure 3 shows the block diagram of the temperature controller. The system is powered by an alternating current (AC) supply from the mains. It connects to a transformer and relay. The transformer steps down the input voltage to 5V to make the current conducive for the system. The input coil is called the primary and the output coil is called the secondary. There is no electrical connection between the two coils; instead they are linked by an alternating magnetic field created in the soft-iron core of the transformer.

The alternating current is converted to direct current (DC) to enable the system utilize it by a process called rectification. Filter circuit removes the traces of AC from the current passing through. This is done using a capacitor. Smoothing is performed by a high valued electrolytic capacitor connected across the DC supply to act as a reservoir, supplying current to the output when the varying DC voltage from the rectifier is falling. The capacitor charges quickly near the peak of the varying DC, and then discharges as it supplies current to the output. The regulator stabilizes the voltage to 5V irrespective of the input voltage changes. The regulated voltage then powers the Arduino microcontroller to do its function.

The Arduino board is connected to a keypad, sensor, display and transistor. LCD display is used to display the temperature being recorded from the microcontroller from the sensor. Sensor is the input component of the system that picks the temperature of the sample. This unit senses or detects the temperature in water. Keypad is also an input component that enables the user to key in information to the system.

The 12V relay (actuator) gets its current from the AC input after being stepped down by the transformer. It is used to control the electrical current that goes to the heater. Transistor (relay drivers) receives information from the Arduino microcontroller that it feeds the relay on whether it should put on or switch off the heater. Heating element gets signal from the relay and it is used to raise the temperature of the water.

2.4 DESCRIPTION AND WORKING PRINCIPLE OF THE SINGLE STAGE EXTRACTOR

The calyces are placed on the wire mesh and then the required amount of water is poured into the vessel and covered. The temperature and time is set to one's desire usually between 90°C and 100°C for effective extraction. Once the time is up, the system goes off. The extract can now be discharged through the tap and the spent calyces can be removed from the system by removing the sieve. The extract can be sweetened and flavoured to taste.

2.5 DESIGN CALCULATIONS

Assumptions

There is no heat loss across the walls of the extractor due to the presence of the insulator. Average room temperature is 25°C.

Sizing of the system

The volume of the system is calculated using equation 1;

$$volume\ of\ vessel(V) = \pi r^2 h \tag{1}$$

$$r = 12.5cm, \quad h = 18cm$$

$$V = \pi * 12.5^2 * 18 = 8836cm^3$$

The maximum allowable volume is 8liters to avoid overflow.

To calculate the energy required to raise the temperature of the system at maximum capacity from 25°C to 100°C. Using heat energy equation 2

$$E = [(m_v * C_v) + (m_m * C_m) + (m_w * C_w) + (m_c * C_c)]\Delta T \tag{2}$$

where $m(g)$ is mass, $C(J/kg\ ^\circ C)$ is specific heat capacity, $T(^\circ C)$ is temperature and subscripts $v, m, w,$

and c represent vessel, mesh, water and calyces respectively.

$$E = [(1 * 502) + (0.25 * 502) + (7 * 4184) + (0.7 * 1700)] * 75$$

$$E = 2,332,912J \tag{3}$$

To calculate the power rating of the heater calculation, it is assumed that the maximum time required to raise the temperature from 25°C to 100°C is 25 minutes which is 1500 seconds. The minimum power rating required is calculated as the rate of doing work which is given as equation (4)

$$P = \frac{E}{t} = \frac{2332912}{1500} = 1555watts \tag{4}$$

A heater of 1800-2000watts is suitable and was used for the extractor.

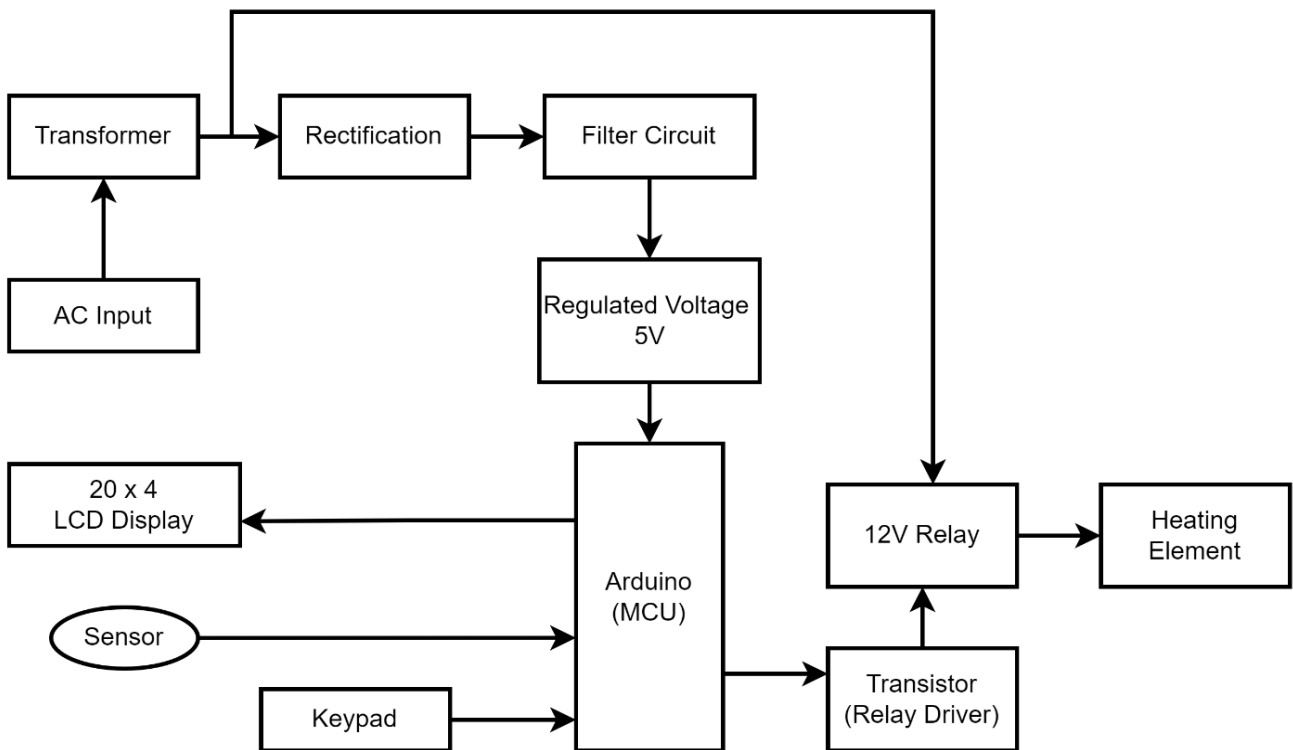

Figure 3: Process flow chart for the temperature controller

2.6 THERMAL EFFICIENCY OF THE SYSTEM

The efficiency is the ratio of energy output to energy input and will be calculated using equations (5) and (6). It was calculated by varying the mass of the calyces from 0g to 500g using 5 and 7 litres of distilled water respectively.

$$\eta = \frac{Energy\ output}{energy\ input} \times 100 \tag{5}$$

$$\eta = \frac{(m_w C_w + m_c C_c)\Delta T}{P \times t} \times 100 \tag{6}$$

2.7 DETERMINATION OF PHYSICAL PROPERTIES

The extraction time, temperature and calyx-solvent ratio were varied to determine their effect on the pH, density and colour of the extract. The pH indicates the level of organic acids such as ascorbic and oxalic acid present in the extract. The density of the extracts relates to the quantity of solute present. The colour indicates the anthocyanin content which is a very important antioxidant present in the calyces. The values of the factors used for the experiment are time 5, 10 and 15 minutes, temperature 30°C, 50°C, 75°C and 100°C and calyx-solvent ratio 1:50, 1:20 and 1:10. The procedures are as described below.

Determination of pH.

The pH of the samples was determined using pH meter manufactured by Mettler Toledo (seven compact series). Samples were properly homogenized in solution using a glass rod. The pH meter was calibrated initially using pH buffer solutions (buffer 4.10 and buffer 10) before use. The buffer solutions are manufactured by Mettler Toledo.

Density

An empty beaker was weighed and recorded. Fifty milliliters of each sample was introduced into a 50ml density bottle. The weight of the density bottle and sample was taken. Sample weight was obtained by subtracting weight of empty density bottle from weight of sample and density bottle. From the sample weight obtained, the density was determined by taking the ratio of the weight of the sample to the known volume (50ml) in SI units as shown in equation (7).

$$\text{density} = \frac{\text{sample mass}}{\text{sample volume}} \quad (7)$$

Tests for colour

The method of [21] was used to evaluate the samples colour. Five milliliters of the sample was diluted in 10 ml of water. An aliquot of the roselle extract sample was placed in a cuvette and distilled water was used as blank and then placed inside a colorimeter (Konica Minolta CR-5) and measured at 530 nm.

2.8 EXPERIMENTAL DESIGN AND STATISTICAL ANALYSIS

The analysis of variance (ANOVA), regression equations and contour plots were produced using Design Expert 11. The central composite design (CCD) with a quadratic model [8] was engaged. The independent variables were extraction time (5, 10 and

15minutes), process temperature (30, 50, 75 and 100°C) and calyx-water mass ratio (1:50, 1:20 and 1:10).

The responses functions (y) were pH, density and colour of the roselle extract. These values were related to the coded variables by a second degree polynomial using equation (8).

$$y = C_0 + \sum_{i=1}^n c_i x_i + \sum_{i=1}^n c_{ii} x_i^2 + \sum_{1 \leq i < j}^n c_{ij} x_i x_j \quad (8)$$

Where, C_0 is defined as the constant, c_i the linear coefficient, c_{ii} the quadratic coefficient and c_{ij} the cross product coefficient x_i and x_j are levels of the independent variables while n equals to the number of the tested factors ($n = 3$). The analysis of variance (ANOVA) tables were generated and the effect and regression coefficients of individual linear, quadratic and interaction terms were determined. The significances of all terms in the polynomial were judged statistically by computing the F-value at probability levels ($p < 0.05$). The regression coefficients were then used to make statistical calculations to generate contour maps from the regression models.

3.0 RESULTS AND DISCUSSION

3.1 PERFORMANCE EVALUATION OF THE EXTRACTOR

Thermal efficiency of the extractor

The efficiency of the extractor at different loading conditions shows that as the mass of the calyces increased, the efficiency reduced as shown in figure 4. This can be attributed to the work done during the heat and mass transfer which occurs during extraction. The t-test conducted on the efficiency data for 5 liters and 7 liters shows that there is no statistical difference in the efficiency using 5 and 7 liters of water for the extraction.

3.2 EFFECT OF TIME, TEMPERATURE AND CALYX-WATER MASS RATIO ON PH

The effect of extraction time, process temperature and calyx-water mass ratio on the pH, density and colour is as shown in Table 1. C represents the coefficients while subscripts 1, 2 and 3 represent linear effects of extraction time, temperature and calyx-water mass ratio respectively. The pH ranged from 2.4 to 2.7 which is similar to pH value gotten by [15]. This shows that the extract becomes more acidic with

increased time, temperature and calyx-water mass ratio.

Time was seen to have a negative significant linear effect ($p < 0.001$) on the pH of the extract. This suggests that within the experimental boundary, an increase in the processing time reduced the pH meaning that the acidity increased. This could mean that more organic acids dispersed into the solvent with an increase in the time of exposure.

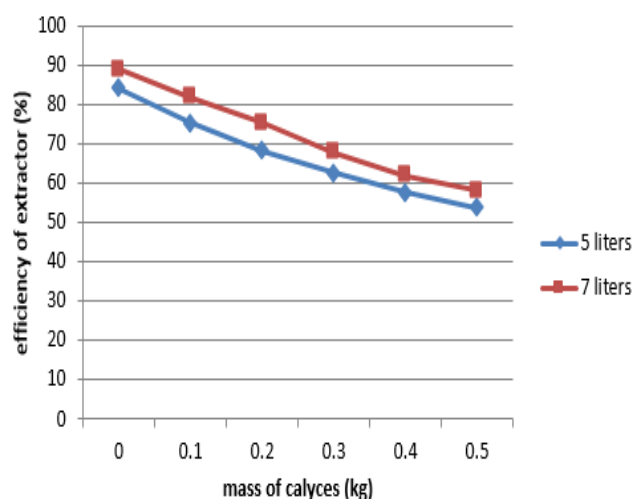

Figure 4: Effect of mass of calyces on the efficiency of extractor

Temperature also had a negative significant linear effect ($p < 0.001$) on the pH of the extract. This suggests that as the temperature increased and approached boiling point and all other factors remaining constant, the pH reduces meaning that the acidity increases. This is similar to what was obtained for soursop juice [22]. This indicates that the increased temperature encourages the more organic acids to be released from the calyces.

There was a negative significant linear effect ($p < 0.001$) of the calyx-water mass ratio on the pH of the extract in that as the mass of the calyces increased, the pH of the extract reduced. This goes to show that the increase in the calyces means that more organic acids are available for extraction.

Time and temperature were seen to have a significant interactive effect ($p < 0.01$) and calyx-water mass ratio was seen to have significant quadratic effect ($p < 0.001$) on the pH of the extract. This interaction could be visualized in the contour plots in figure 5 where the time at 9 minutes and temperature of 50°C produced an extract with pH of 2.7.

Table 1: Regression coefficients, R^2 , adjusted R^2 and p values for three dependent variables for roselle extraction

	pH	Density	Colour
Intercept	2.576642	1.035991	1.832714
C₁	-0.05604***	-0.00033	0.257699***
C₂	-0.11371***	0.005568***	1.232204***
C₃	-0.1295***	0.003369***	0.693246***
C₁₂	0.040776**	-0.00077	-0.09427
C₁₃	0.008333	-0.00052	-0.02605
C₂₃	0.006118	0.001795**	0.064047
C₁₁	0.009583	0	-0.07135
C₂₂	-0.0225	0	0.152607
C₃₃	0.078148***	0	-0.30614**
R²	0.791	0.685	0.855
Adjusted R²	0.771	0.667	0.841
P values	0.0001***	0.0001***	0.0001***

Subscripts: 1 = extraction time; 2 = extraction temperature. 3 = calyx-water mass ratio

*Significant at 0.05 level.

**Significant at 0.01 level.

***Significant at 0.001 level.

3.3 EFFECT OF TIME, TEMPERATURE AND CALYX-WATER MASS RATIO ON DENSITY

From Table 1, time was seen not to have any significant effect on the density of the extract. It indicates that no matter how long the extraction process goes on, the density will not change much. This could be as a result of the extraction of the solute taking place about 10 minutes into the extraction as observed by [1].

It was observed that temperature had a positive linear significant effect ($p < 0.001$) on the density of the extract. This means that as the extraction temperature increased, the density of the extract increased. In other words, temperature plays an important role in the diffusion of solutes from the calyces to the solvent.

Calyx-water mass ratio played an important role in the density of the extract as it had a positive linear significant effect ($p < 0.001$) on it. An increase in the mass of calyx with constant mass of water increased the density of the extract. This could be as a result of increased availability of the solute in the system [23]. Temperature and calyx-water mass ratio was also seen to have a significant interaction effect ($p < 0.01$) on the density of the extract which can be seen in the contour plots presented in figure 6. None of the factors had a quadratic significant effect on the density of the extract.

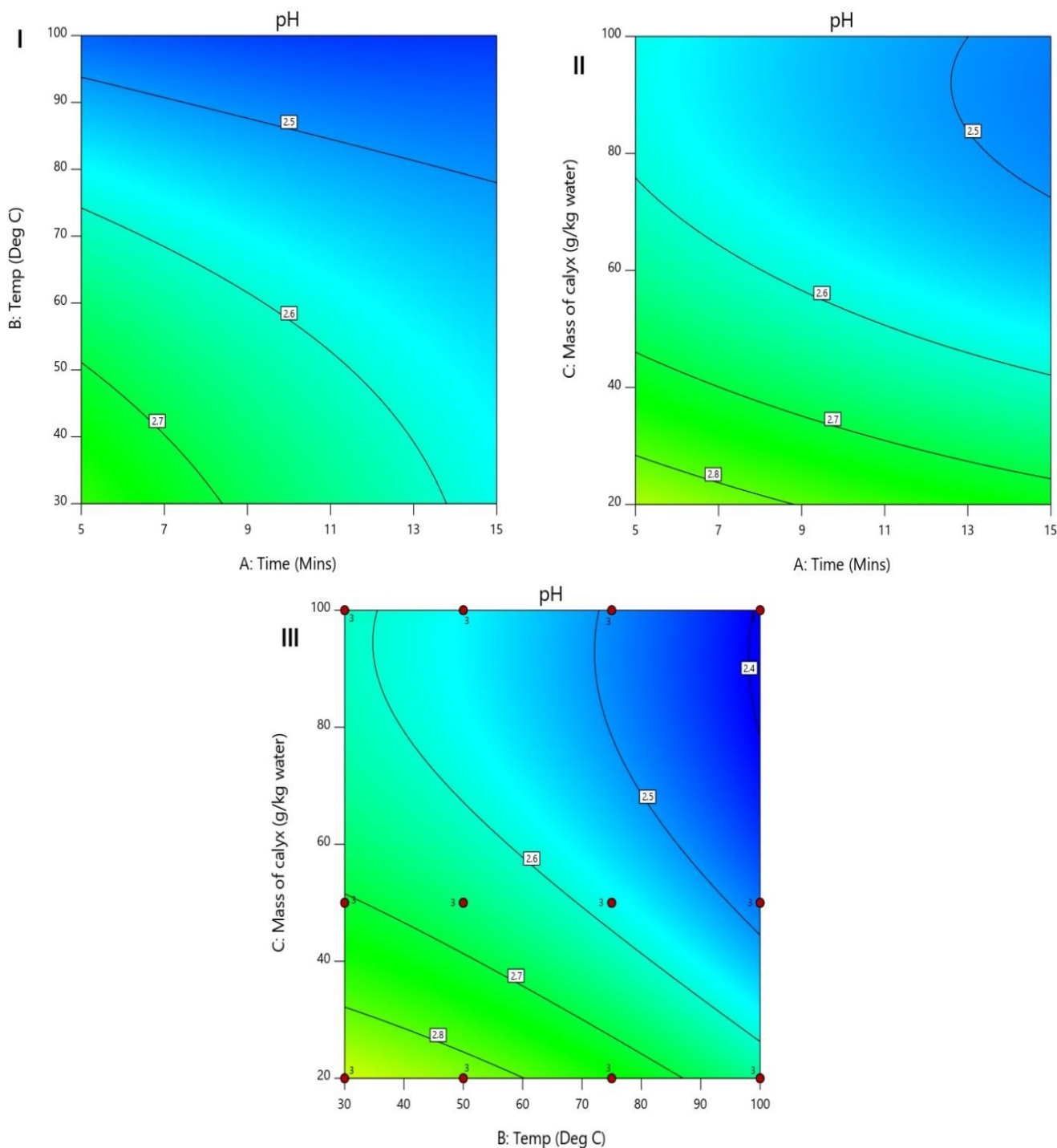

Figure 5: Contour plots showing effect of time, temperature and calyx-water mass ratio on the pH of the extract

3.4 EFFECT OF TIME, TEMPERATURE AND CALYX-WATER MASS RATIO ON COLOUR

As seen in Table 1, time was seen to have a positive significant linear effect ($p < 0.001$) on the colour of the extract. This means that within the experimental boundary, and all other factors remaining constant, as

time increased, the reddish colour of the extract became deeper. Anthocyanin is responsible for the red colour of the extract [24] and this observation indicates that as time increased, the more anthocyanin was leached into the solvent.

Temperature had a positive significant linear effect ($p < 0.001$) on the colour of the extract. As temperature approached the boiling point, the extract became redder, all other factors remaining constant. Just like most reactions, temperature plays a significant role in the rate of chemical and biological reactions. Temperature did not have any significant interaction or quadratic effect on the colour of the extract. The interaction of the factors on the colour of the extract is presented in the contour plots in figure 7.

Calyx-water mass ratio has a positive significant linear effect ($p < 0.001$) on the colour of the extract. As the mass of the calyces increased, the colour of the extract becomes redder which indicates that the solvent has access to more anthocyanin from the calyces. The calyx-water mass ratio was the only factor that had a significant quadratic effect ($p < 0.01$) on the colour of the extract.

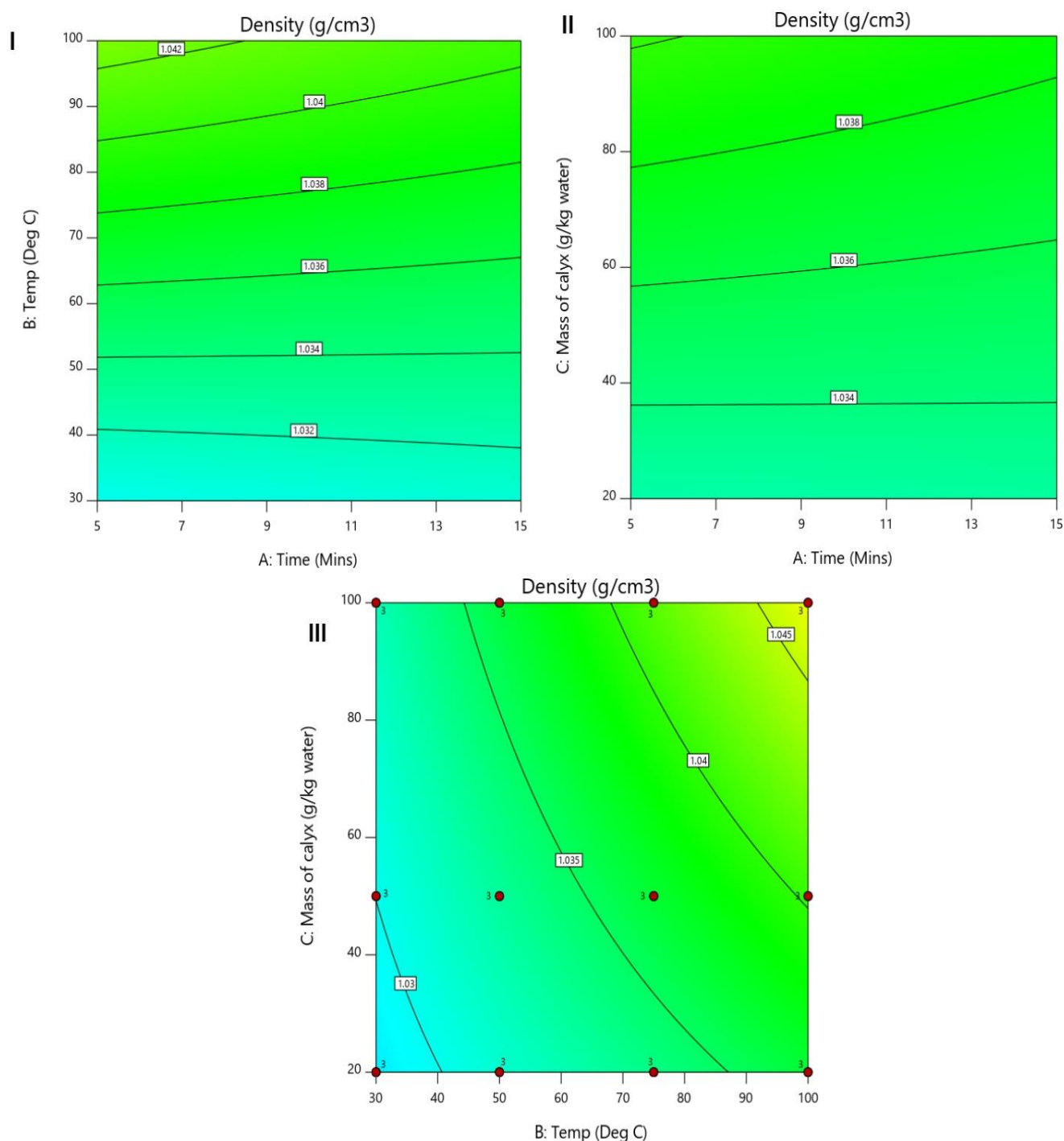

Figure 6: Contour plots showing effect of time, temperature and calyx-water mass ratio on the density of the extract

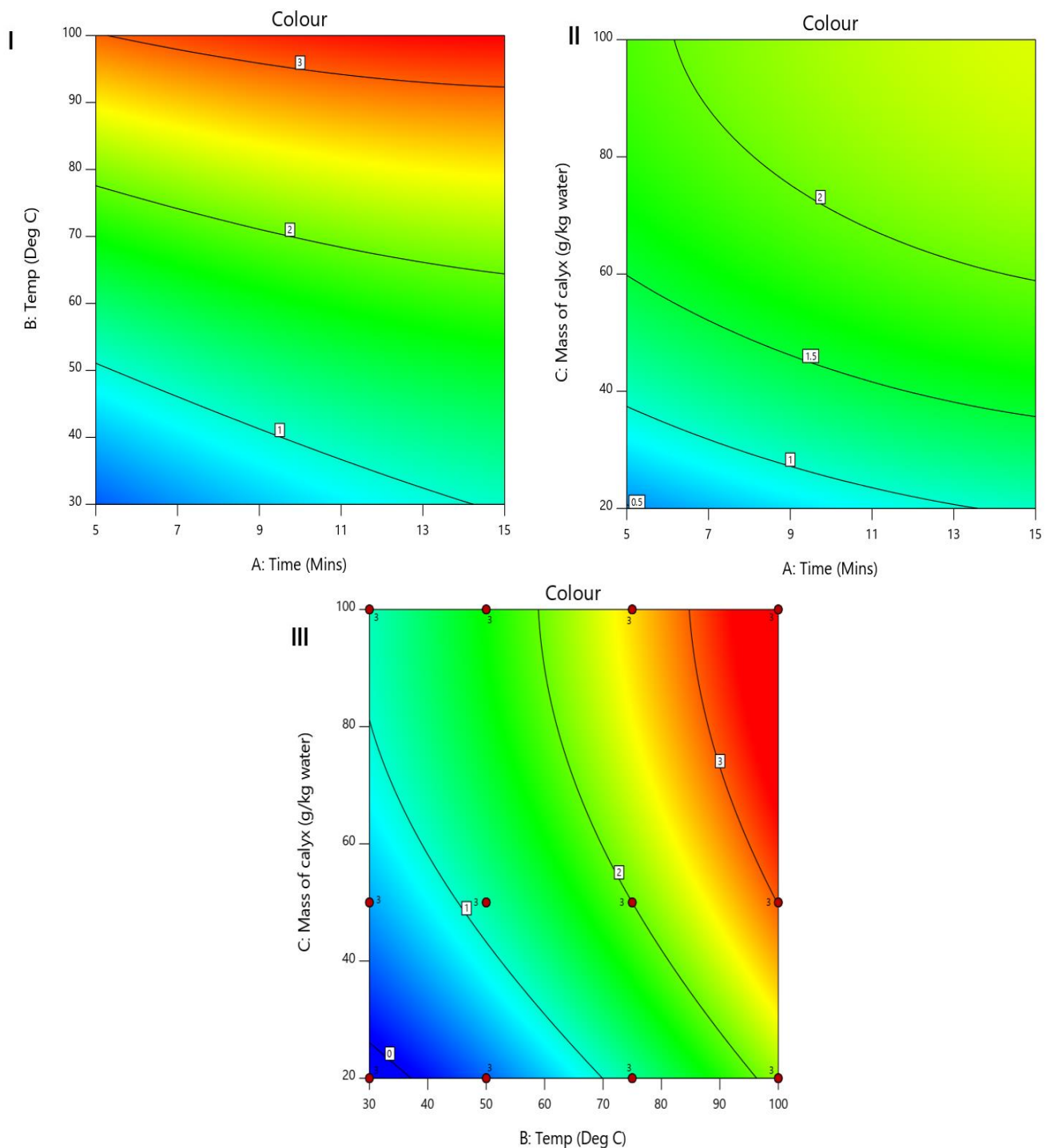

Figure 7: Contour plots showing effect of time, temperature and calyx-water mass ratio on the colour of the extract

4.0 CONCLUSION

A single stage roselle calyx batch extractor was developed with the ability to conduct extraction at different temperatures between 30 and 100°C. It was observed that efficiency of the system varied at different loading conditions. This extractor can be used to prepare extract of up to 8 liters per batch. The

physical and hygienic safety of the system were taken into consideration and the materials selection was according to standard practices. It was also observed that processing conditions during extractions play a vital role in the outcome of the physical properties of the extract. Time, temperature and calyx-water ratio had significant effect on the pH, density and colour of

the extract. This study will enable food processors to know the best processing parameters to use to ensure utmost quality of the extracts.

REFERENCES

- [1] Cissé, M., Bohuon, P., Sambe, F., et al. "Aqueous extraction of anthocyanins from *Hibiscus sabdariffa*: Experimental kinetics and modeling", *J Food Eng.* 2012; 109:16–21.
- [2] Arowosafe, K. O., Bamgboye, A. I., Adesanya, A. A., et al. "Biofuel Production from Locally Sourced Roselle (*Hibiscus Sabdariffa L.*) Seed Oil Using Transesterification Process", *Niger J Technol.* 2022; 41:191–196.
- [3] Isaac Bamgboye, A., and Adejumo, O. I. "Physicochemical properties of Roselle seed oil", *Nutr Food Sci.* 2010; 40:186–192.
- [4] Juliani, H. R., Welch, C. R., Wu, Q., et al. "Chemistry and Quality of Hibiscus (*Hibiscus sabdariffa*) for Developing the Natural-Product Industry in Senegal", *J Food Sci.* 2009; 74:S113–S121.
- [5] Wong, P., Yusof, S., Ghazali, H. M., et al. "Physico-chemical characteristics of roselle (*Hibiscus sabdariffa L.*)", *Nutr Food Sci.* 2002; 32:68–73.
- [6] Abdelhameed, R. M., Rocha, J., and Silva, A. M. S. "Selective separation of hibiscus acid from Roselle extracts by an amino-functionalized Metal Organic Framework", *J Chromatogr A.* 2021; 1636:461789.
- [7] Ali, B. H., Wabel, N. A., and Blunden, G. "Phytochemical, pharmacological and toxicological aspects of *Hibiscus sabdariffa L.*: a review", *Phytother Res.* 2005; 19:369–375.
- [8] Lee, W-C., Wang, C-J., Chen, Y-H., et al. "Polyphenol Extracts from *Hibiscus sabdariffa* Linnaeus Attenuate Nephropathy in Experimental Type 1 Diabetes", *J Agric Food Chem.* 2009; 57:2206–2210.
- [9] Lin, H-H., Chen, J-H., Kuo, W-H., et al. "Chemopreventive properties of *Hibiscus sabdariffa L.* on human gastric carcinoma cells through apoptosis induction and JNK/p38 MAPK signaling activation", *Chem Biol Interact.* 2007; 165:59–75.
- [10] Bule, M., Albelbeisi, A. H., Nikfar, S., et al. "The antidiabetic and antilipidemic effects of *Hibiscus sabdariffa*: A systematic review and meta-analysis of randomized clinical trials", *Food Res Int.* 2020; 130:108980.
- [11] Sindi, H. A., Marshall, L. J., and Morgan, M. R. A. "Comparative chemical and biochemical analysis of extracts of *Hibiscus sabdariffa*", *Food Chem.* 2014; 164:23–29.
- [12] Ahmed, Z. S., and Abozed, S. S. "Functional and antioxidant properties of novel snack crackers incorporated with *Hibiscus sabdariffa* by-product", *J Adv Res.* 2015; 6:79–87.
- [13] Mayo-Mayo, G., Navarrete-García, A., Maldonado-Astudillo, Y. I., et al. "Addition of roselle and mango peel powder in tortilla chips: a strategy for increasing their functionality", *J Food Meas Charact.* 2020; 14:1511–1519.
- [14] Singo, T., and Beswa, D. "Effect of roselle extracts on the selected quality characteristics of ice cream", *Int J Food Prop.* 2019; 22:42–53.
- [15] Jung, E., Kim, Y., and Joo, N. "Physico-chemical properties and antimicrobial activity of Roselle (*Hibiscus sabdariffa L.*)", *J Sci Food Agric.* 2013; 93:3769–3776.
- [16] Ajayi, O. A., and Oyerinde, M. O. "Evaluation of Nutritional composition of Roselle (*Hibiscus sabdariffa*) herbal Tea infused with Ginger (*Zingiber officinale*) and Lemon (*Citrus limon*) Peel", 2020; 7.
- [17] Aloba, A. P., and Offonry, S. U. "Characteristics of Coloured Wine Produced from Roselle (*Hibiscus sabdariffa*) Calyx Extract", *J Inst Brew.* 2009; 115:91–94.
- [18] Cid-Ortega, S., Guerrero-Beltrán, J. A. "Roselle calyces (*Hibiscus sabdariffa*), an alternative to the food and beverages industries: a review", *J Food Sci Technol.* 2015; 52:6859–6869.
- [19] Umogbai, V. "Design, Construction and Evaluation of Zobo Juice Processing Device", *Br J Appl Sci Technol.* 2015; 5:490–499.
- [20] Tsai, P-J., McIntosh, J., Pearce, P., et al. "Anthocyanin and antioxidant capacity in Roselle (*Hibiscus Sabdariffa L.*) extract", *Food Res Int.* 2002; 35:351–356.
- [21] Truong, V. D., Hu, Z., Thompson, R. L., et al. "Pressurized liquid extraction and quantification of anthocyanins in purple-fleshed sweet potato genotypes", *J Food Compos Anal.* 2012; 26:96–103.
- [22] Jerry, A-A., and Bright, Q. "Effect of storage temperature on the physicochemical, nutritional and microbiological quality of pasteurised soursop (*Annona muricata L.*) Juice", *Afr J Food Sci.* 2019; 13:38–47.
- [23] Cacace, J. E., and Mazza, G. "Mass transfer process during extraction of phenolic compounds from milled berries", *J Food Eng.* 2003; 59:379–389.
- [24] Cisse, M., Vaillant, F., Acosta, O., et al. "Thermal Degradation Kinetics of Anthocyanins from Blood Orange, Blackberry, and Roselle Using the Arrhenius, Eyring, and Ball Models", *J Agric Food Chem.* 2009; 57:6285–6291.